

COMPANY PROFILE



P.T. IAPMO GROUP INDONESIA

Assurance | Confidence | Progressive

The IAPMO Group

- Established in 1926 – almost 100 years
- Our Main Goal is International Public Health & Safety with Environmental Awareness
- A complete service organization
 - Code Development
 - Standard Development
 - Industry-leading Education and Professional Qualification
 - Conformity Assessment (Testing, Certification, Inspection, Evaluation Services, Management System Registration)



P.T. IAPMO GROUP INDONESIA



Working Relationships

- Governments (such as U.S. EPA WaterSense ®, U.S. EPA ENERGY STAR®, DOE, NIST, U.S. AID, etc.)
- Non Governmental Organizations (such as WHO, ANSI, ISO, ASME, ASSE, ASTM, PMI, etc.)
- MoUs with numerous entities in Taiwan, China, Indonesia, Europe, South America, and throughout the Asia Pacific Region
- Active involvement with World Plumbing Council (WPC)

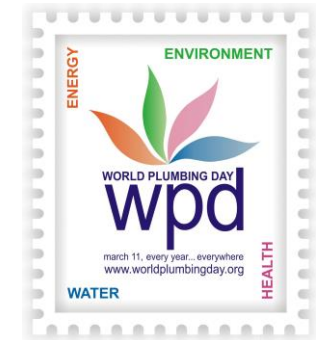

History of IAPMO

Now: The IAPMO Group has 28 offices all over the worlds with more than 5,000 members

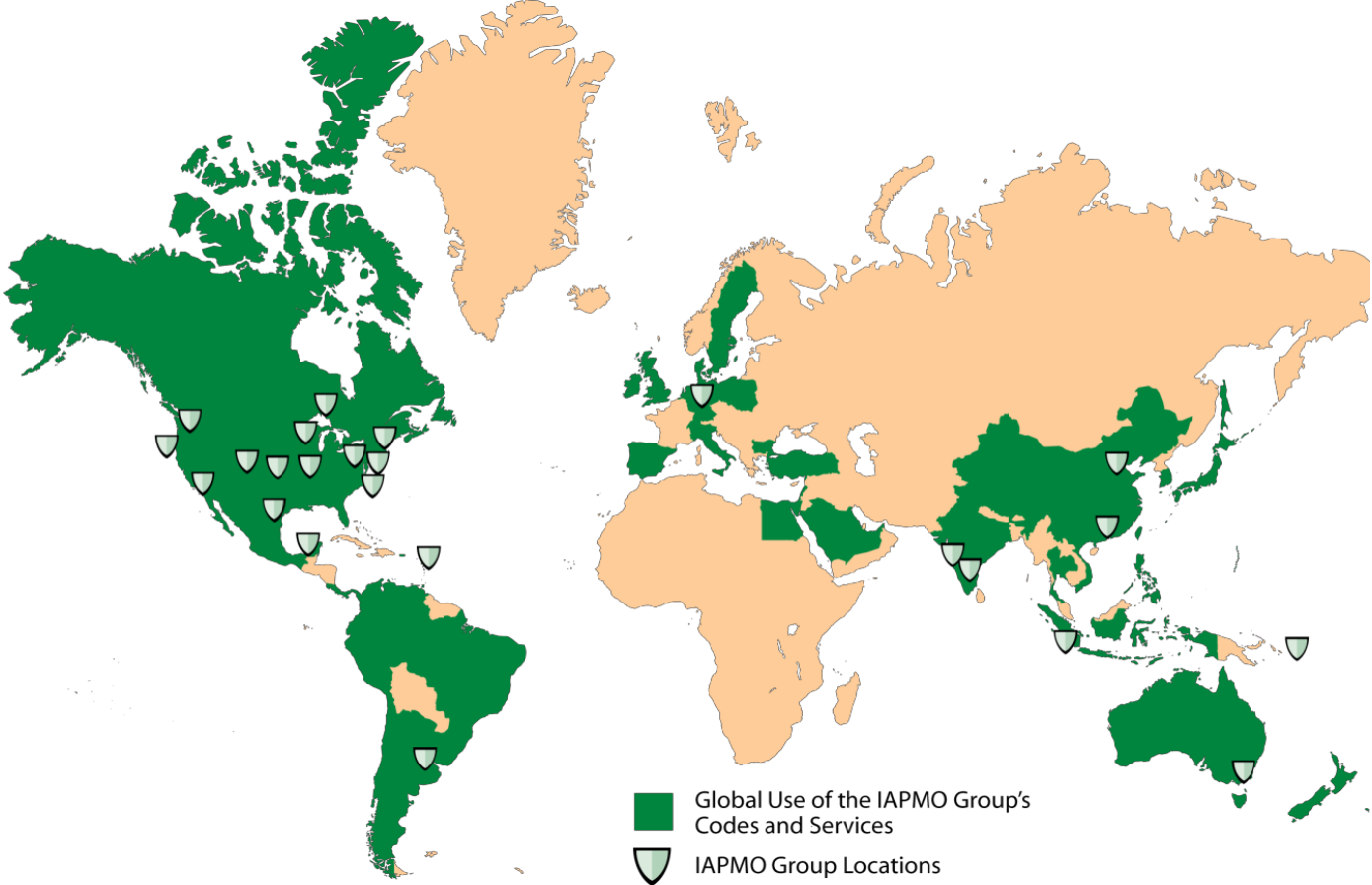

IAPMO Group



Sustainability



Electrical-Gas-Solar
Product Certification



Test Laboratories



Product Standard
Development

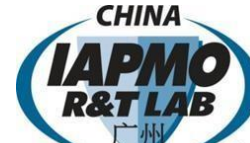

IAPMO R&T
Lab China



Management
System and
Supply Chain



Building Materials
Test Laboratory



Building Product
Evaluations



Codes-Education-
Training



ASSE
International



India Code Adoption
& Training



IAPMO Group
Indonesia



Building Materials
Inspection



Australia & New
Zealand



Backflow Prevention
Institute



Product
Certification



Radiant Professionals
Alliance



IAPMO DEA



Plumbing Test
Laboratory



About IAPMO Group Indonesia

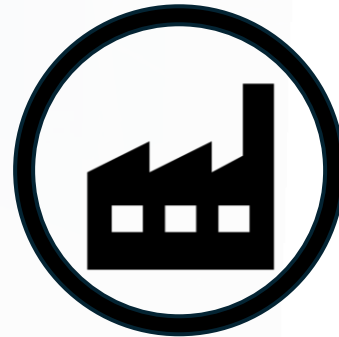

- **Established on May 17, 2016**



- **Located in Cikarang, www.iapmoindonesia.org**



About Us

PT IAPMO Group Indonesia (IGI) is a complete service conformity assessment body and a subsidiary of the IAPMO Group with headquarter office in Ontario, California - USA.

IGI was established in 2016 to support the Indonesian government in the development of plumbing system standard and related conformity assessment activities. Since its inception, IGI has extended its commitment to the Indonesian government beyond plumbing to include supports for construction, building, mechanical, hygiene and sanitation, food equipment, and many more areas for standardization and conformity assessment. IGI also supports the advancement of green and sustainability measures in Indonesia.

IGI's head office and laboratory facility is located in Cikarang, Indonesia's largest industrial area, and is ready to serve industrial stakeholders to enter both the Indonesian market and international market.

OUR GOAL

Public Health and Safety with
Environmental Awareness



ASSURANCE. CONFIDENCE. PROGRESSIVE



IAPMO Group Indonesia Journey

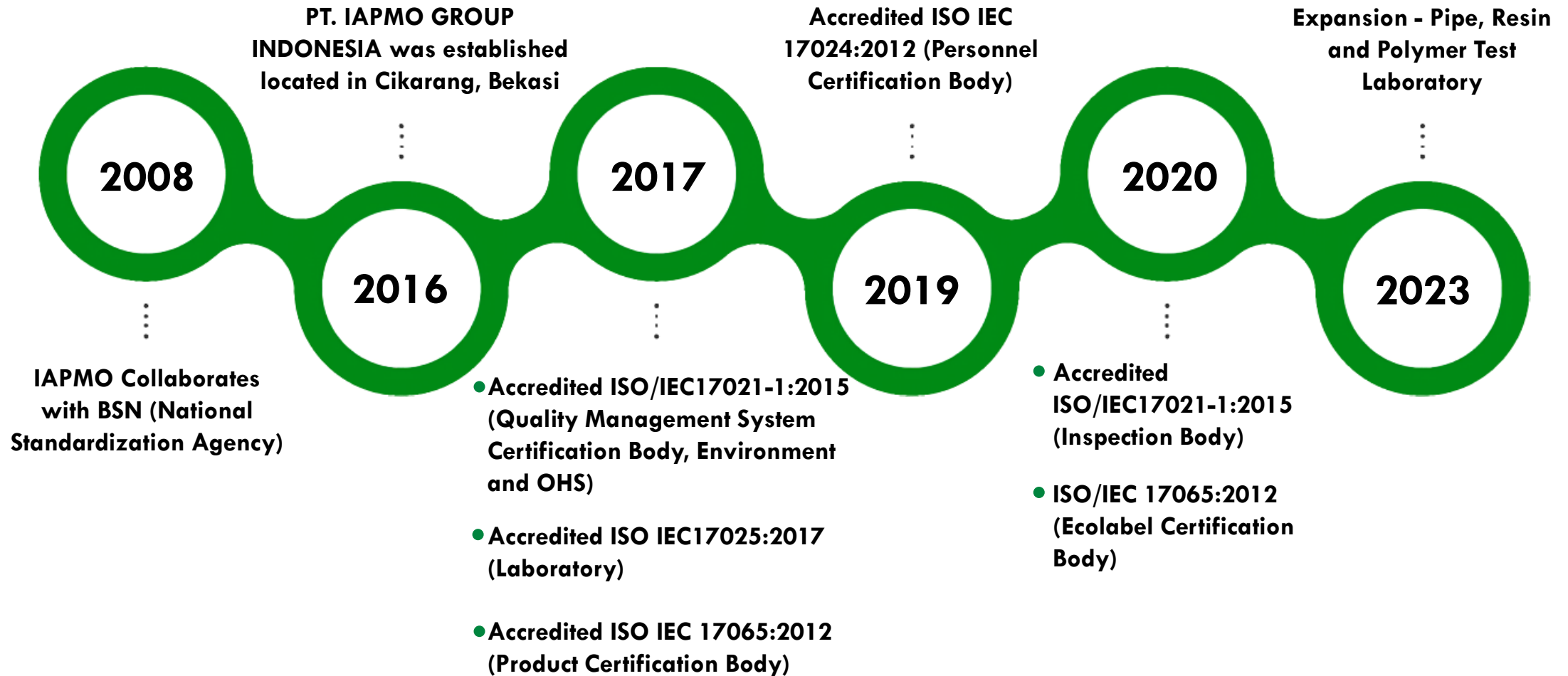

Working Relationships IAPMO Group Indonesia



- **BSN** (Badan Standardisasi Nasional) Standard development related to plumbing.



- **GPCI** (Green Product Council Indonesia) Appointment as the verification agency for Green Label Indonesia.



MoU with the Center for Research and Development of Housing and Settlements **Kementerian PUPR** – Plumbing System Inspection for Sertifikasi Laik Fungsi (SLF) for buildings.



- MoU with **PERPAMSI** (Persatuan Perusahaan Air Minum Seluruh Indonesia) aimed at ensuring product quality assurance and enhancing the competency of plumbing members.



- PT IAPMO Group Indonesia was appointed by the Ministry of Industry as a Conformity Assessment for the implementation of several Mandatory SNI products.



- Collaboration with the Ministry of Environment and Forestry regarding the implementation of Type 1 (whole product criteria) based on ISO 14024 and SNI ecolabel and Type 2 Based on ISO 14021 (Self declaration based on environmental claims)



- The PI IAPMO Group Indonesia has agreed to collaborate on the assessment of the Green Toll Road Indonesia (GTRI). GTRI is a Green Assessment standard for toll road sections, which includes six indicators such as access, feasibility and service, energy and water efficiency, environment, materials, construction, and regional cooperation. These indicators aim to align with the Sustainable Development Goals (SDGs)

Accreditations



**Test Laboratory
(Laboratorium Uji)
LP – 1079 - IDN**

**Product Certification Agency
(Lembaga Sertifikasi Produk)
LSPro – 054 -IDN**

**Inspection Agency
(Lembaga Inspeksi)
LI – 162 - IDN**

**Personnel Certification Agency
(Lembaga Sertifikasi Personil)
LSP – 019 - IDN**

**Ecolabel Certification Agency
(Lembaga Sertifikasi Ekolabel)
LSE - 003 - IDN**

**Quality System Certification
(Sertifikasi Sistem Mutu)
LSSM - 043 - IDN**

ONE-STOP CONFORMITY ASSESSMENT SERVICES

CERTIFICATION



TESTING

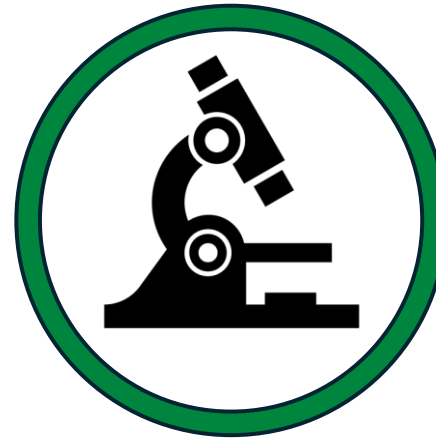

INSPECTION



TRAINING





CERTIFICATION

GREEN CERTIFICATION SCHEME



- **Green Label Indonesia**



Ramah Lingkungan

- **Ecolabel Type 1**



- **Ecolabel Type 2**

For Product : Bricks, Ceramic Tiles, Gypsum, Instant Mortar, Light Steel Profile, Portland Cement, PVC Pipe, Sheet Steel, Adhesive & Sealant, Carpet, Flat Glass, Floor, Covering, Furniture, Paint & Coating, Sanitary Ware, Window Film, Air Conditioning, Lighting, Food Packaging, etc.

PERSONEL CERTIFICATION

Plumbing Specialist Level 1 to 4 based on SNI 8153:2015

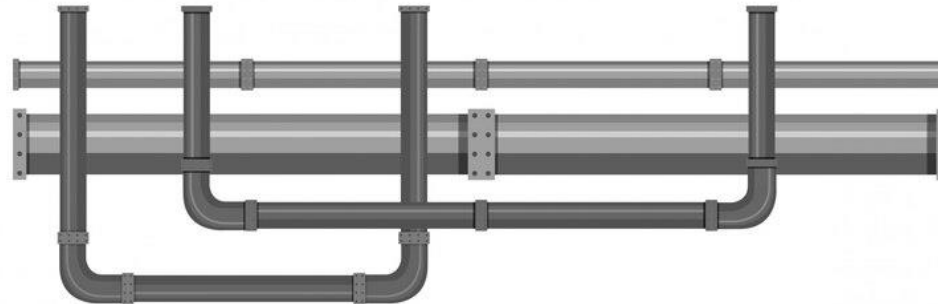

MANAGEMENT SYSTEMS CERTIFICATION



ISO 9001

Quality Management
System



ISO 14001

Environmental Management
System



ISO 45001

Occupational Health and
Safety Management



ISO 50001

Energy Management
System



ISO 37001

Anti-bribery
Management System

PRODUCT CERTIFICATION (SNI)

SNI Product: Ceramic Tiles, Ceramic Tableware, Water Closet, Safety Glass: Tempered and Laminated, Mirror, Block Glass, Pipes (PVC, PE, PP), Fittings (PVC, PE, PP), Water Meter, Water Tank, Steel Pipe, Malleable Cast Iron Fitting, Plumbing Fitting (Faucet/tap, Shower, Waste Fitting, Flushing Device), Plumbing Fixtures (Bathtub, Urinal, Wash Basin/Sink, Lavatory), Sheet Steel, Profile Steel, Concrete Steel, Wire Steel, Portland Cement, High-Pressure Decorative Laminates, Wall and Decorative Paint, Cookware, Flatware, Truss, etc.

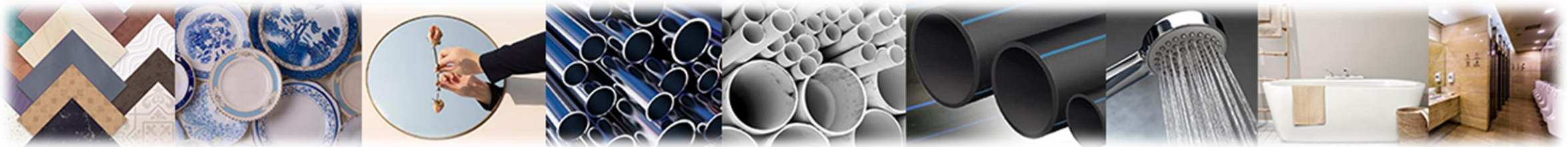

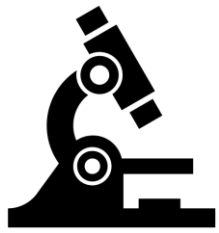

TESTING

MARKET ACCESS



SASO

(Kingdom of Saudi Arabia)



United Arab Emirates

UAE

(United Arab Emirates)

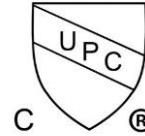

cUPC

(USA and Canada)



BPS

(Philippines)

LABORATORY SERVICES

COMMODITY TESTING

Ceramic Tile, Ceramic Tableware, Water Closet (Western & Eastern), Plumbing Fitting (Faucet/tap, Shower, Waste Fitting, Flushing Device), Plumbing Fixtures (Bathtub, Urinal, Wash Basin/Sink, Lavatory), Safety Glass: Tempered and Laminated, Mirror, Block Glass, Cookware, Flatware, Truss, etc.

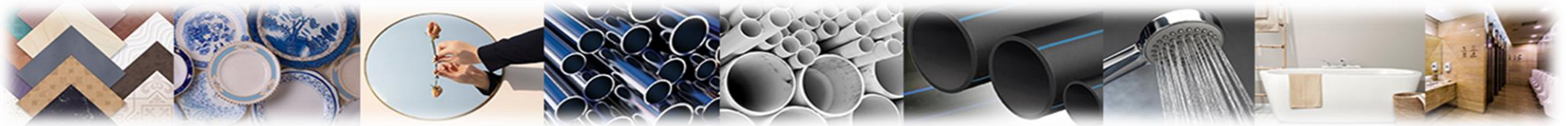

OTHER TESTING

Metal and Alloy, Coating Tensile <5000kgf, Corrosion Resistance, Chemical and Stain Resistance, Impact Resistance.



INSPECTION

INDUSTRIAL SERVICES

- Energy Audit for Mapping Energy Consumption
- Plant Safety Assessment
- Fire and Explosion Risk Assessment

INSPECTION SERVICES

- Good Hygiene Rating Inspection Services for Hotel, Restaurants and Catering
- Hygiene Rating Inspection Service for UMKM

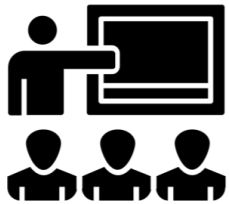

TRAINING

TRAINING SERVICES

- ISO 9001 : Quality Management System
- ISO 14001: Environmental Management System
- ISO 45001: Occupational Health and Safety
- ISO 50001: Energy Management System

- ISO 22000: Food Safety Management
- Hygiene and Sanitation for Hotel, Catering, and Restaurants
- HACCP & GMP
- Plumbing Systems for Buildings (SNI 8153:2015)



Some Of Our Client



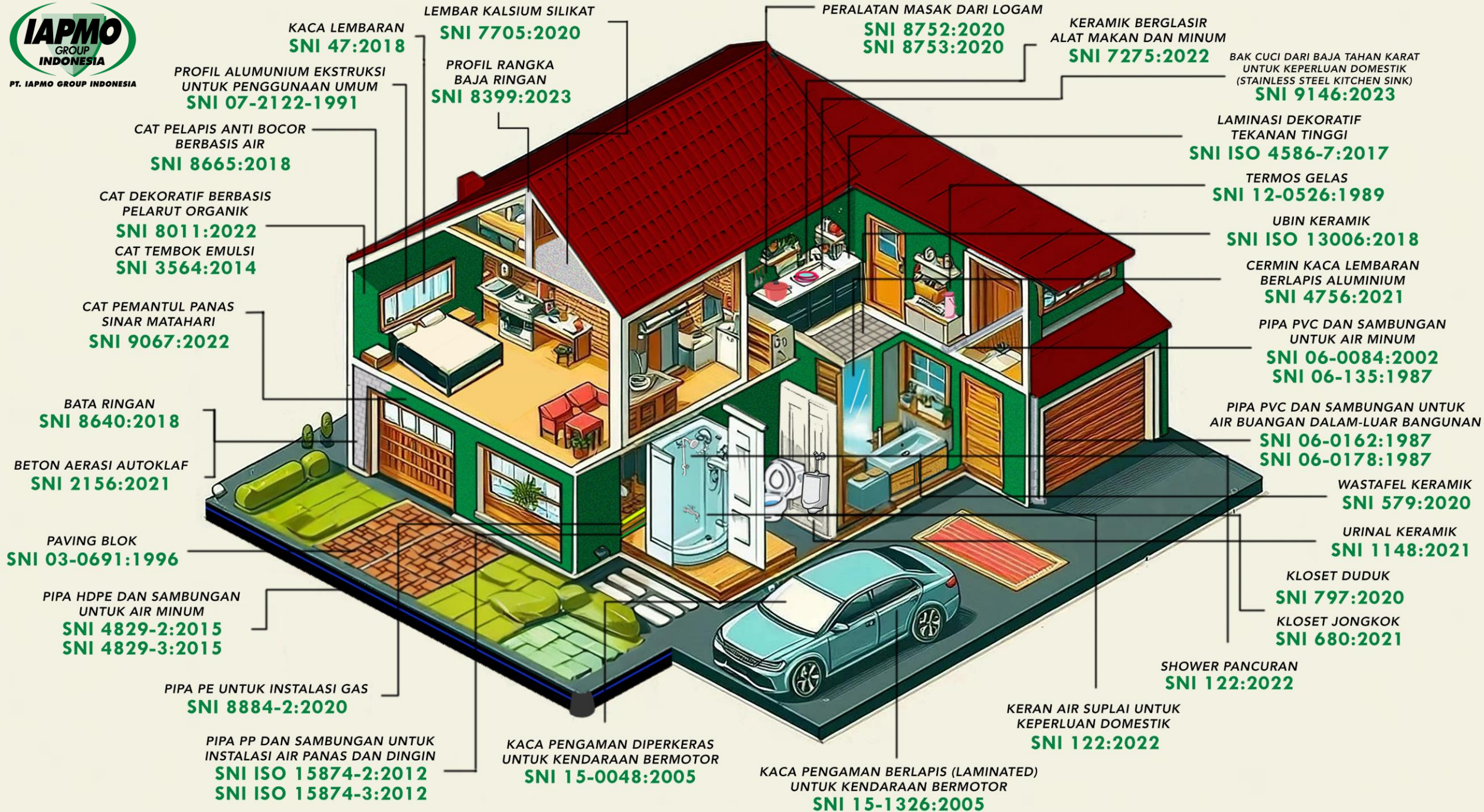

KACA LEMBARAN
SNI 47:2018

PROFIL ALUMINIUM EKSTRAKSI
UNTUK PENGGUNAAN UMUM
SNI 07-2122-1991

CAT PELAPIS ANTI BOCOR
BERBASIS AIR
SNI 8665:2018

CAT DEKORATIF BERBASIS
PELARUT ORGANIK
SNI 8011:2022
CAT TEMBOK EMULSI
SNI 3564:2014

CAT PEMANTUL PANAS
SINAR MATAHARI
SNI 9067:2022

BATA RINGAN
SNI 8640:2018

BETON AERASI AUTOKLAF
SNI 2156:2021

PAVING BLOK
SNI 03-0691:1996

PIPA HDPE DAN SAMBUNGAN
UNTUK AIR MINUM
SNI 4829-2:2015
SNI 4829-3:2015

PIPA PE UNTUK INSTALASI GAS
SNI 8884-2:2020

PIPA PP DAN SAMBUNGAN UNTUK
INSTALASI AIR PANAS DAN DINGIN
SNI ISO 15874-2:2012
SNI ISO 15874-3:2012

LEMBAR KALSIMUM SILIKAT
SNI 7705:2020

PROFIL RANGKA
BAJA RINGAN
SNI 8399:2023

KACA PENGAMAN DIPERKERAS
UNTUK KENDARAAN BERMOTOR
SNI 15-0048:2005

PERALATAN MASAK DARI LOGAM
SNI 8752:2020
SNI 8753:2020

KACA PENGAMAN BERLAPIS (LAMINATED)
UNTUK KENDARAAN BERMOTOR
SNI 15-1326:2005

KERAMIK BERGLASIR
ALAT MAKAN DAN MINUM
SNI 7275:2022

KERAN AIR SUPLAI UNTUK
KEPERLUAN DOMESTIK
SNI 122:2022

BAK CUCI DARI BAJA TAHAN KARAT
UNTUK KEPERLUAN DOMESTIK
(STAINLESS STEEL KITCHEN SINK)
SNI 9146:2023

LAMINASI DEKORATIF
TEKANAN TINGGI
SNI ISO 4586-7:2017

TERMOS GELAS
SNI 12-0526:1989

UBIN KERAMIK
SNI ISO 13006:2018

CERMIN KACA LEMBARAN
BERLAPIS ALUMINIUM
SNI 4756:2021

PIPA PVC DAN SAMBUNGAN
UNTUK AIR MINUM
SNI 06-0084:2002
SNI 06-135:1987

PIPA PVC DAN SAMBUNGAN UNTUK
AIR BUANGAN DALAM-LUAR BANGUNAN
SNI 06-0162:1987
SNI 06-0178:1987

WASTAFEL KERAMIK
SNI 579:2020

URINAL KERAMIK
SNI 1148:2021

KLOSET DUDUK
SNI 797:2020

KLOSET JONGKOK
SNI 680:2021

SHOWER PANCURAN
SNI 122:2022



INAUGURATION OF PIPE AND RESIN LAB



INAUGURATION OF PERPAMSI MEMBERS





TRAINING AND CERTIFICATION PERSONNEL





P.T. IAPMO GROUP INDONESIA



PTIAPMOIndonesia



@IAPMO_Indonesia



@IAPMO



pt-iapmo-indonesia

Contact Us

Ketut Putra



0812-8953-0108



ketut.putra@iapmoindonesia.org

Novi Ariani



0822-1726-5709



novi.ariani@iapmoindonesia.org

Lusy Aulia



0821-1197-0960



sales@iapmoindonesia.org

0218-9911-467

info@iapmoindonesia.org